

CE RoHS

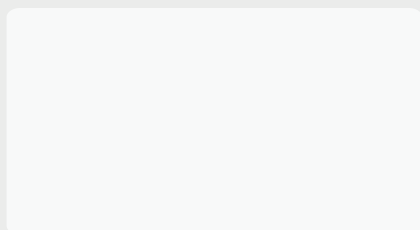

THIS PRODUCT SHOULD NOT BE DISPOSED WITH OTHER HOUSEHOLD WATES AT THIS END OF ITS WORKING LIFE. IN ORDER TO BE RECYCLE, PLEASE BRING YOUR PRODUCT IN A CERTIFIED RECYCLING CENTER.



E'LOO

83 Series **USER MANUAL**

Thank you for purchasing E'LOO electronic bidet.

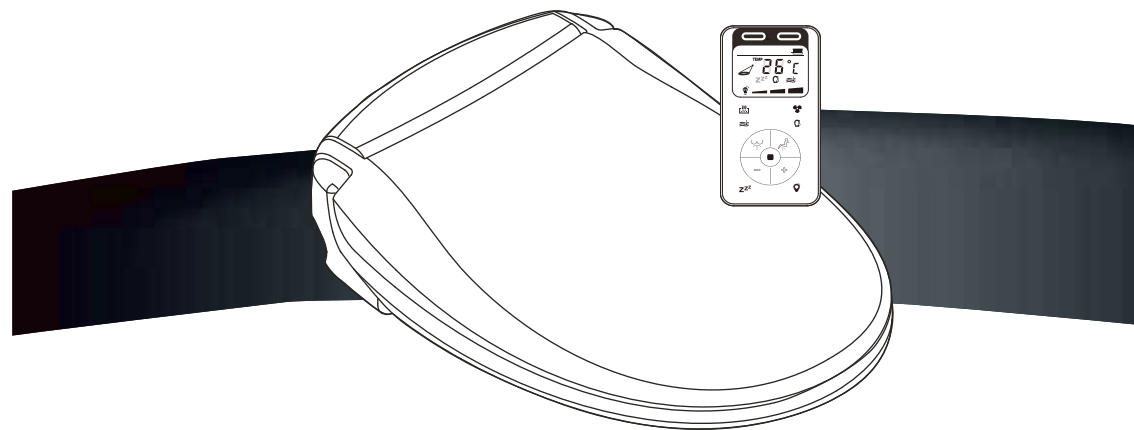

 Please read the manual carefully prior to use

SUMMARY

01. Safety Precaution	03
02. Configuration	08
03. Installation	09
04. How To Use	11
05. Features	13
06. Maintenance	14
07. If the product is not use for a long period	15
08. Troubleshootings	16
09. Specification	18
10. Warranty Certificate	19

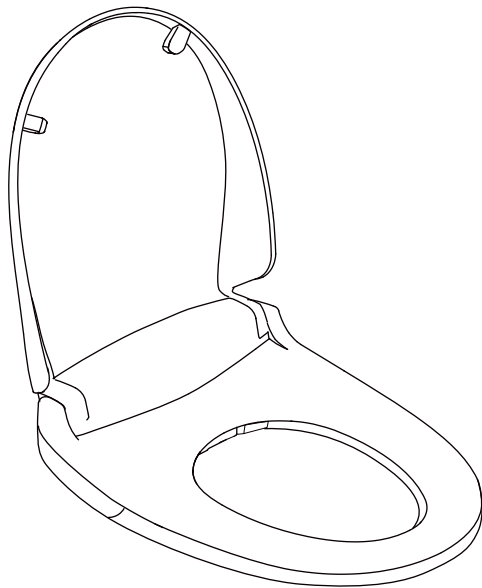

Warranty Certificate

Please fill in the blanks with the needed information of your warranty certificates immediately after installation.

In case of question to our after sales services they will be asked to you.

NAME OF THE PRODUCT : E'LOO
NAME OF THE MODEL : **83 Series**
PRODUCT SERIALN :
(At the backside of the main unit)
PURCHASING DATE :
WARRANTY :

The manufacturing warranty is provided with in 1 year from the purchasing date (on the invoice).

The warranty includes services and all needed spare parts.

The warranty is only valid if all needed elements are given with a copy of the original invoice.

The warranty is valid for all defected parts resulting from manufacturing.

The warranty is not valid for parts damaged by the user or by installation non conform to E'LOO recommendations, for instance :

If the product had been disassemblea or repaired by non official technician from E'LOO.

The installation is not conforming to E'LOO recommendation.

The use is not conforming to E'LOO precaution of use.

The connection has been done on a non conforming plug.

Or all other damages caused by use or an installation that is not indicated in the E'LOO User Manual.

Specification

		83 Series Round	83 Series Elongated
Standard Power Voltage	110V / 220V 60Hz / 50 Hz		
Length Of The Power Cord	1.2m		
Supply Water Pressure	from 5 pascal to 69 pascal		
Heated Water	1200W (max.)		
Heated Seat	52W (max.)		
Heated Dryer	130W (max.)		
Electrical Safety Protection	15mA-GFCI		
Product	Dimension (mm)	470L x 385W x 107H	520L x 385W x 107H
	Net Weight	3.4 ± 0.3 Kg	
	Gross Weight	4.8 ± 0.5 Kg	
Certification	CE, RoHS		

Safety Precaution

IMPORTANT SAFETYGUARDS

- ⚠ DANGER :** If not observed, serious injury or even death may occur as a result of electrocution.
- ⚠ WARNING :** If these warnings, are not observed, considerable physical injury or property damage may occur as a result of burns, electrocution, fire, or injury.
- ⚠ CAUTION :** If these cautions are not observed, slight physical or property damage may occur.

READ ALL INSTRUCTIONS BEFORE USING. Save these instructions for future reference.

When using electrical products, especially when children are present, basic safety precautions should always be taken:

⚠ DANGER: To reduce the risk of electrocution

Failure to observe the following warnings may result in electric shock, fire, personal injury, property damage or product damage :

- Do not use a damaged power plug or loose electric outlet.
- Make sure to use a dedicated electrical outlet. Failing to do so may result in electric shock or fire.
- Do not move the product by pulling the power cord.
- Do not handle the power plug with wet hands.
- Do not forcefully bend the power cord or place heavy objects on it to prevent it from being damaged or deformed.
- Do not connect and pull out the power plug repeatedly.
- Unplug the product before cleaning, repairing, inspecting, or replacing parts.
- Remove any dust or water from the power plug.
- Do not plug the appliance into an electrical outlet or power strip that is being used by too many appliances.
- Use an electrical outlet adequate for the wattage of the product.
- If the supply cord is damaged, it must be replaced by the manufacturer, its service agent or similarly qualified persons in order to avoid a hazard.

⚠ DANGER: To reduce the risk of electrocution

- If the product produces a strange noise, a burnt smell, or emits smoke, unplug it immediately from the electrical outlet and call E'LOO Service Center. Failing to do so may result in electric shock or fire.
- Do not insert a wire or sharp object in any product gaps or the warm air outlet. This may result in electric shock, fire, or product damage.
- Do not place an electric heater near the product or dispose of any burning materials such as a lit cigarette in the toilet. This may result in fire or product deformation.
- Do not place any containers filled with water, medicine, food any metallic objects, or any flammable material on top of the product. If foreign material enters the product, this may result in electric shock or fire.
- Do not use the product in locations exposed to excessive moisture and do not splash water onto the product.
- Do not use the product if it is not working properly.
- Please unplug the product immediately, and call E'LOO Service Center after closing the main water supply valve. Failing to do so may result in electric shock or fire.
- While taking a shower or cleaning the bathroom, pull the power plug out of the electrical outlet and exercise caution that water or detergent does not splash onto the bidet. Failing to do so may result in electric shock or fire.
- If foreign material enters the product, pull the power plug out of the electrical outlet, turn off the main water valve, and call the E'LOO Service Center.
- Do not disassemble, repair, or modify the product yourself.
- Do not use the product while bathing.
- Do not place or store the product where it can fall or be pulled into a tub or sink.
- Do not place in or drop the product into water or any other liquid.
- Do not reach for the product if it has fallen into water. Unplug the product immediately. And call the E'LOO Service Center.

Prior to contact our after sales service, please contact the E'LOO in order to get further information for the warranty procedure.

To facilitate the procedure, please prior answer the following questions?

QUESTIONS TO ANSWER :

The product is no more operating :

- 1- Isn't the power connection cable unplugged?
- 2- Isn't the power ON/OFF button switch off?
- 3- Does LED lamp on the control panel blinks or lights?
- 4- Is the user detected by the seat digital sensor?

Washing functions is no more operating :

- 1- Isn't the water supply valve shut off?
- 2- Isn't there any water leakage on the water supply connection pipe?
- 3- Isn't the water supply connection pipe clogged with foreign elements?
- 4- Isn't the nozzle clogged with foreign elements?
- 5- Isn't the nozzle clogged with limestone accumulation?
- 6- Is the LED lamp light or blinks?

Water pressure is weak :

- 1- Is the water supply valve fully open?
- 2- Isn't the water supply connection pipe clogged with foreign elements?
- 3- Isn't the water pressure level set to a too low level?

Water, air and seat temperature is no more operating :

- 1- Is the product connected to the plug?
- 2- Isn't the power ON/OFF button switch off?
- 3- Isn't the temperature level set to a too low level?

Troubleshooting

Please check the following before calling for service

Issue	Possible Cause	Solution
The water wash can not work properly	<ul style="list-style-type: none"> • The bidet is plugged in improperly • Shut-off valve shut down • The seat sensor is not activated properly • Abnormal water leaking 	<ul style="list-style-type: none"> • Plug in the power cord again • Open the shut-off valve • Adjust your sitting position • Tighten the connectors of hoses
Low water pressure	<ul style="list-style-type: none"> • The water supply hose bent • Filter clogged • Holes of nozzles clogged 	<ul style="list-style-type: none"> • Fix the water supply hose in position • Clean the water filter • Clean the nozzles
Unexpected stop water wash when it is working	<ul style="list-style-type: none"> • Water wash shut down • User left the seat sensor • Abnormal water supply 	<ul style="list-style-type: none"> • Unplug the power cord for system reset • Adjust your sitting position • Check the water supply providing properly
Remote control malfunction	<ul style="list-style-type: none"> • Can not receive the IR signal • Low battery • User left the seat sensor 	<ul style="list-style-type: none"> • Move the location of remote control • Recharge the battery • Adjust your sitting position
Seat not heated	<ul style="list-style-type: none"> • Seat temp. set to off • Remote malfunction 	<ul style="list-style-type: none"> • Reset the seat temp. (See remote control malfunction)
Water not heated	<ul style="list-style-type: none"> • Water temp. set to off • Remote malfunction 	<ul style="list-style-type: none"> • Reset the water temp. (See remote control malfunction)
Dryer malfunction	<ul style="list-style-type: none"> • Dryer temp. set to off • Remote malfunction 	<ul style="list-style-type: none"> • Reset the dryer temp. (See remote control malfunction)
Deodorant malfunction	<ul style="list-style-type: none"> • User not proper seated • Remote malfunction 	<ul style="list-style-type: none"> • Adjust sitting position (See remote control malfunction)



Check if there is any abnormal status

- Constant leakage from product
- Crack on the seat
- There is no power when plug
- Burnt smell near the seat
- Electricity leakage
- Other malfunctions



Please stop using.

- Unplug the power cord.
- Close shut-off valve.
- Call the Service.

- Do not block the warm air outlet with your hand.
- Close supervision is necessary when this product is used by children or persons requiring general assistance.
- Use this product for its intended use only, as described in this manual. Do not use any attachments that are not recommended by E'LOO.
- Never block the air openings of the product or place it on a soft surface, such as a bed or couch, where the air openings may be blocked. Keep the air openings free of lint, hair, etc.
- Never drop or insert any object into any opening or hose.
- Do not use the product outdoors or operate where aerosol (spray) products are being used or where it could be exposed to oxygen.
- Unplug this product before filling. Fill (reservoir) with water only unless otherwise specified by the manufacturer. Do not overfill (or specify filling instructions).

CAUTION:

Failure to observe the following warnings may result in electric shock, fire, personal injury, property damage or product damage:

- Do not connect the main water to the hot water pipe (only connect to cold water supply).
- After the installation, make sure to check all water supply connections for leaks. Rubber washers should be in place for the water connection hoses & T-Valve.
- Exercise caution that urine does not come into contact with the nozzles or warm air dryer outlet-failure to do so may result in bad odors or malfunction.
- If the product will not be used for a long period of time unplug the power cord, close the main water supply valve, and drain any water in the water tank.
- Do not pull out the bidet hose or connection hose using excessive force.
- This appliance is not intended for use by persons [including children] with reduced physical, sensory or mental capabilities, or lack of experience and knowledge, unless they have been given supervision or instruction concerning use of the appliance by a person responsible for their safety. Children should be supervised to ensure that they do not play with the appliance.

Grounding & GFI Outlet Instructions

This product should only be used with a grounded GFI (Ground Fault Interrupter) outlet and a grounded 3 prong electrical cord as shown in figure A. In the event of an electrical short circuit, using a grounded GFI outlet reduces the risk of electric shock.

This product is equipped with a grounded cord and is for use on a

nominal 110V/220V circuit only (min 15 amps) and must be plugged into an outlet that is properly grounded with a GFI breaker as shown. Replace or repair a damaged cord immediately.

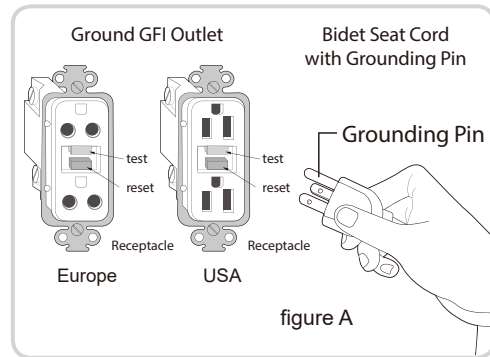

⚠ DANGER : Improper use of the grounding plug can result in a risk of electric shock.

- If repair or replacement of the cord or plug is necessary, do not connect the grounding wire to either flat blade terminal. The wire with insulation having an outer surface that is green with or without yellow stripes is the grounding wire.
- Check with a qualified electrician or serviceman if the grounding instructions are not completely understood, or if in doubt as to whether the product is properly grounded.

Extension Cord

If it is necessary to use an extension cord, use only a three wire extension cord with a threeblade grounding plug, and a three-slot receptacle that will accept the plug of the product. Replace or repair a damaged cord immediately.

In case the product is not use for a long period, we recommend to fully respect following operation :

STEP 1 Unplug the power cord.

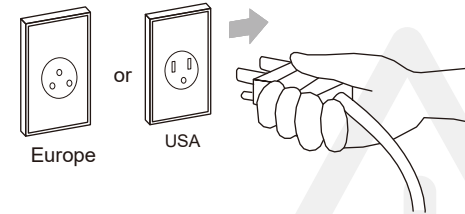

STEP 2 Turn off the tap water shut-off valve.

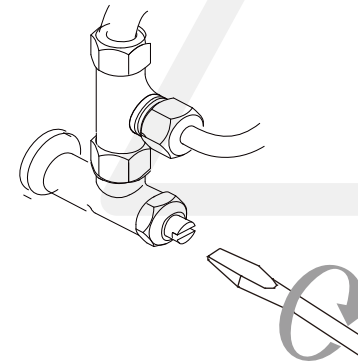

PRIOR TO REUSE THE 85 Series :

STEP 1 Open the water supply valve of the 85 Series.

STEP 2 Plug in the power cord.

Maintenance

- !** Do not spray water or cleaner directly on the seat. Wipe the product and components with a soft damp cloth.
Please keep dry and well ventilated place where installed the seat. A humid environment should cause the seat malfunction.

1 Cleaning The Seat

Apply to water, 75% diluted alcohol or soft detergent on soft cloth for wiping clean the seat.

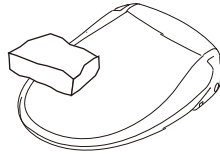

2 Cleaning The Toilet Fixture

1. Press the detach button to remove the seat.
2. Clean up the corner and surface of toilet fixture.
3. Re-install the seat onto toilet fixture and make it sure mounted properly with hearing "click" sound.

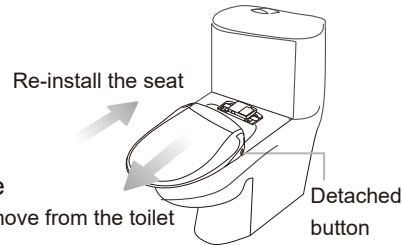

3 Cleaning The Nozzles

1. Apply to soft detergent on brush to clean nozzles and wands regularly.

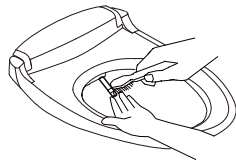

Safety Precaution

- !** Do not use the product if it is working improperly, and call for Service :



Set the temperature of wash spray, warm air dryer, and seat to "low" or "off" to prevent burning.



The product should be used with correct electrical current only to avoid possible fire or shock. An approved residual current device (RCD) must be used.



Do not self disassemble, repair or modify the seat.



Do not water on the seat directly, this could result in damage.



Do not use hard brushes or abrasive detergent to clean this product. Use only neutral detergent and a damp soft cloth for cleaning.



Keep any flammable material away from the seat all the time to prevent a fire hazard happen.



Do not stand or weight heavily on the seat to prevent seat cracking or causing people injury.



Do not bend or pinch the hose : It could affect the normal water supply and cause malfunction or improper working.



During low water pressure, skin burn may occur due to the water temperature coming out from the nozzles increase rapidly. Extra care is needed.



Avoid dropping the remote or getting wet : it will cause malfunction. Do not press the buttons using excessive force.







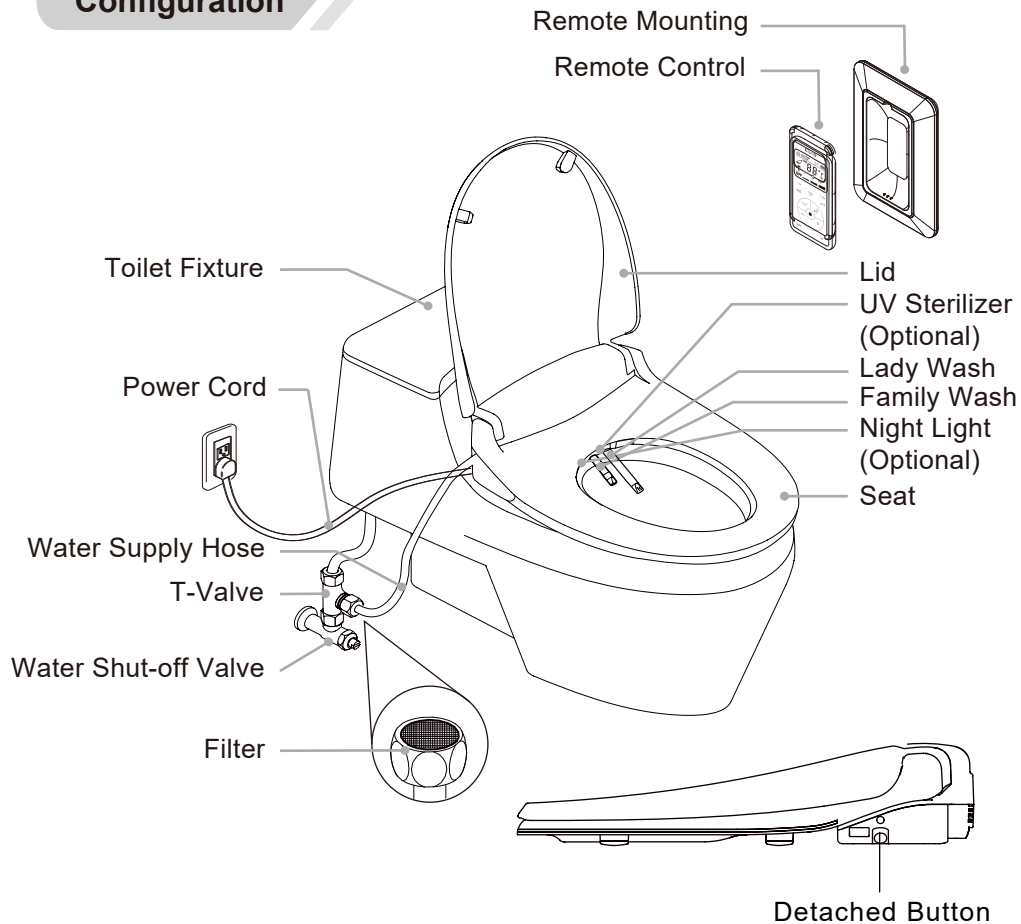

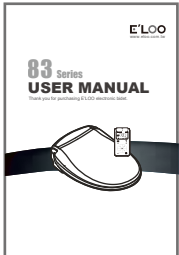

If the product is not to be used for an extended period of time, unplug the power cord. Never operate this product if it has a damaged cord or plug, if it is not working properly, if it has been dropped or damaged, or dropped into water. Return the product to a service center for examination and repair. Connect this product to a properly grounded outlet only. Refer to the Grounding Instructions.

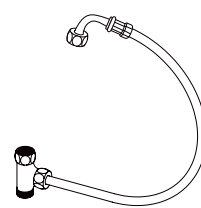
Configuration

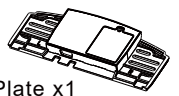

Accessories

Instruction	Parts	T-valve & Hose	Remote Control
	 Screw x2  Washer x2	 T-valve x1 / Hose x1	 Phillips screws x2
	 Plastic Nut x2		 Wall Plugs x2
	 Mounting Plate x1		 Remote Control Mount x2

Features

It is the way - Water wash is the most cleaning as well as refreshing your body after toilet.



Remote Control

The advanced technology-touch panel with device on the unit, you can recharge the battery simply plug into the port on the product



Fit Most Toilet Fixture

Accomodate most toilet fixtures in the market. Also, installing seat is simple and does not require to renew the old toilet installment.



Family Wash

A rear wash with stream of water which cleans an individual's posterior more thoroughly.



Warm Air Dryer

Providing an additional touch of tender service to dry the moisture that staying on the buttock after washing and less toilet paper usage.



Lady Wash

A smoothing, non irritating washing much providing more comfortable, hygienic, experience.



Warm Seat

Adjust the seat temperature to their preferred temperature in accordance with the external weather conditions as well as their personal needs.

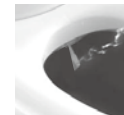

SPA Wash

The unique nozzle design that produces concentrated and spraying swirls of water which ultimately promotes cleanness with its massaging effects.



Night Light

LED night light that illuminates the entire toilet bowl. It makes toilet environment more comfortable and safety.



Dual Nozzle Design

Two self-cleaning retractable wands are designed, one for the family cleanse and another one for the lady cleanse.

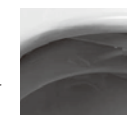

UV Sterilization (Optional)

The all-new UV light device eliminates germs and harmful bacteria for improved hygiene.



Active Carbon Deodorization

It is programmed to eliminate the odors when someone is pressing the button to turn on.



Anti-Bacterial Material

The nozzles and seat made by a special germ-resistant plastic that offers up to 99.8% of anti-bacterial protection.



Quick Release

Push the button located at the back right side of the seat, and you can release the seat from the mounting plate friendly.



Gentle Closing Seat & Lid

The design allows the seat and lid to close softly which is safety and less noisy.



Built-In T-Valve

A built-in filter that purifies the water before going into the product.



Power Save Model

It adopts a power saving feature to make power conservation when it is not in use.

⚠ Important Notice

※ Ensuring the seat sensor is initiated before water wash

※ Nozzles self-cleaning and UV sterilization (Optional)

1. Nozzles self-cleaning will be activated automatically before and after each use.
2. The UV light is activated for 3 mins duration automatically when user left the seat.

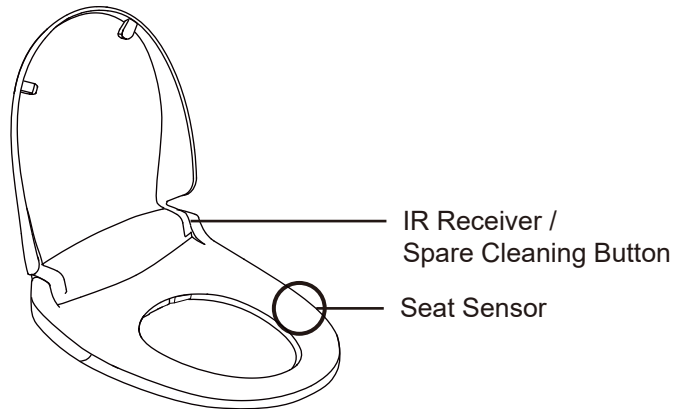

Installation

Step 1. Before installation

1. Remove the existing toilet seat.
Steps may vary by type of seat.

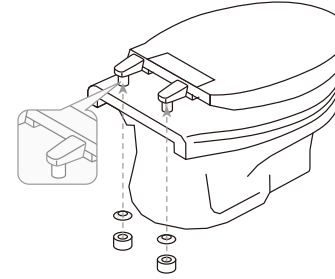

2. Close the water supply shut-off valve near the wall and flush the toilet to empty the water tank.

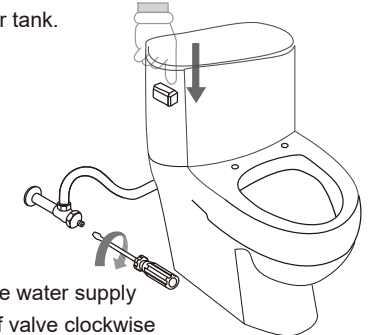

Step 2. Connect T-valve and Hoses

The T-valve is required to install properly as the built-in filter keeps out the impurities from the tap water. Failure to do so could result in leaking.

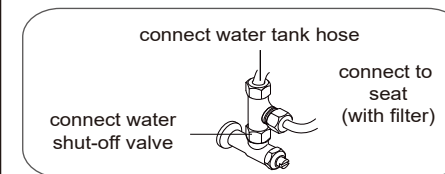

Step 3. Install Mounting Plate

The mounting plate and washers must be assembled correctly as instructed.

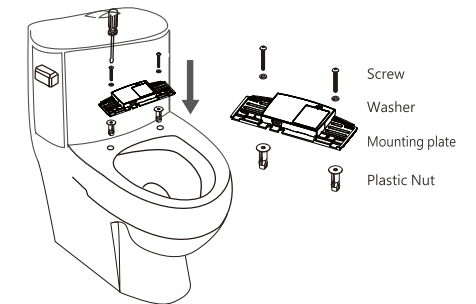

Step 4. Attaching & Detaching the product

Slide the product onto the mounting plate. You will hear a "Clicking" indicating the seat has been properly attached.

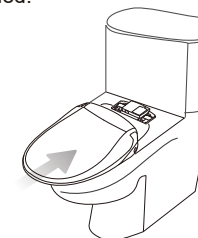

Step 5. Pre-Test

1. Slide the seat onto the mounting plate.
A "clicking" sound indicating means that the seat has been mounted properly.
2. Turn on the water valve in place. And then enjoy your One Touch electronic bidet.

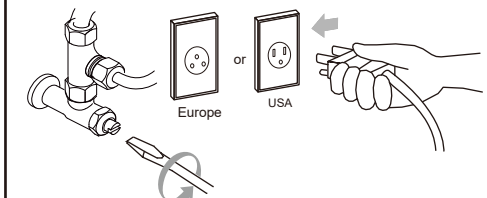

Remote Control Installation

Recharge the battery

The fastest way to recharge the battery is using the included USB charging cord via USB port on the seat until the power status shows full charge state. Also you can use other USB port to charge. (5V only)

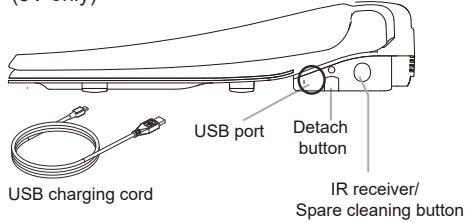

About the lithium battery

- Do not use primary battery.
- When replacing the battery, use new battery of the same brand.
- If the battery leaks, please place the battery inside a plastic bag. And going to the battery-recycling centers.

Load Battery

Load the lithium battery into the remote control as shown below. Tighten the battery cover with screws.

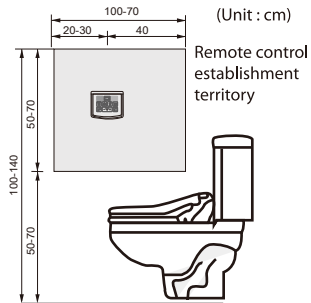
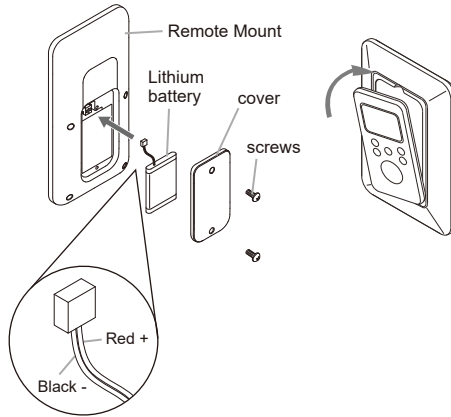

(Unit : cm)
Remote control establishment territory

INSTALLATION OF THE REMOTE CONTROL

Test the position of the remote control to ensure it will operate properly. The transmission signal of the remote control may be interfered by lamp of bathroom (Triphosphor lamp) or direct rays of the sun.

Identify a location for the visible and reachable from the product and that does not obstruct the IR signal coming from the top of the remote control.

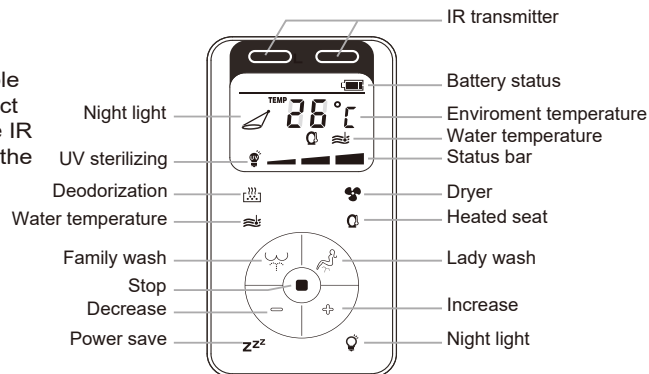

How To Use

Features	Instruction										
Family Wash Lady Wash	1. Select a cleansing mode. Press or button. 2. While cleaning, press + / - button to adjust the water pressure. 3. Press STOP button to stop the cleaning. The cleaning can last for 3 minutes then will stop automatically for safety reason.										
SPA Wash	1. While cleansing, press the same button to turn into SPA wash mode. SPA wash is a massage function created by a rhythmical pulsation of water pressure. 2. Press the same button again to return the original mode.										
Water Temperature	1. Select the designated temperature by pressing button. 2. 4 levels of water temperature OFF-L-M-H to select. <table border="1"> <tr> <td>Status bar</td> <td>OFF</td> <td>-</td> <td>--</td> <td>---</td> </tr> <tr> <td>Water Temp</td> <td>Room temp</td> <td>35±2°C</td> <td>37±2°C</td> <td>39±2°C</td> </tr> </table>	Status bar	OFF	-	--	---	Water Temp	Room temp	35±2°C	37±2°C	39±2°C
Status bar	OFF	-	--	---							
Water Temp	Room temp	35±2°C	37±2°C	39±2°C							
Dryer Temperature	1. Select the designated temperature by pressing button. 2. 4 levels of dryer temperature OFF-L-M-H to select. 3. Please press STOP button to stop the dryer. <table border="1"> <tr> <td>Status bar</td> <td>OFF</td> <td>-</td> <td>--</td> <td>---</td> </tr> <tr> <td>Dryer Temp</td> <td>Room temp</td> <td>36±2°C</td> <td>38±2°C</td> <td>40±2°C</td> </tr> </table>	Status bar	OFF	-	--	---	Dryer Temp	Room temp	36±2°C	38±2°C	40±2°C
Status bar	OFF	-	--	---							
Dryer Temp	Room temp	36±2°C	38±2°C	40±2°C							
Seat Temperature	1. Select the designated temperature by pressing button. 2. 4 levels of seat temperature OFF-L-M-H to select. <table border="1"> <tr> <td>Status bar</td> <td>OFF</td> <td>-</td> <td>--</td> <td>---</td> </tr> <tr> <td>Seat Temp</td> <td>Room temp</td> <td>35±2°C</td> <td>37±2°C</td> <td>39±2°C</td> </tr> </table>	Status bar	OFF	-	--	---	Seat Temp	Room temp	35±2°C	37±2°C	39±2°C
Status bar	OFF	-	--	---							
Seat Temp	Room temp	35±2°C	37±2°C	39±2°C							
Deodorization	Press button to turn on / off deodorization.										
Night Light	Press button to turn on / off the night light. The light will turn on when plug in.										
Power Save	Select the designated power saving hours by pressing button. When the power save is ON, the bidet will be activated when someone sits on. Please reset if you want to continue the power save. <table border="1"> <tr> <td>Status bar</td> <td>OFF</td> <td>-</td> <td>--</td> <td>---</td> </tr> <tr> <td>Hours</td> <td>Room temp</td> <td>4 hours</td> <td>8 hours</td> <td>12 hours</td> </tr> </table>	Status bar	OFF	-	--	---	Hours	Room temp	4 hours	8 hours	12 hours
Status bar	OFF	-	--	---							
Hours	Room temp	4 hours	8 hours	12 hours							
Spare Cleaning Button	When the remote control is not working. You can press the round spare cleaning button to activate Family wash. Press again to stop.										
Time Setting	1. Press STOP button to enter the time setting mode. 2. Press + to adjust the hour, and press - to adjust the minute. 3. Press STOP button to complete the setting.										
Temperature Display	Press button, the temperature display unit will turn from °F to °C or from °C to °F.										
UV Sterilizing Light (Optional)	Sixty seconds after each use, UV light will be activated automatically. The sterilization process will be lasting for 3 minutes.										