

8TF USER MANUAL

Thank you for purchasing E'LOO electronic bidet.
Please read carefully before product installation and keep in a place you can reach easily.

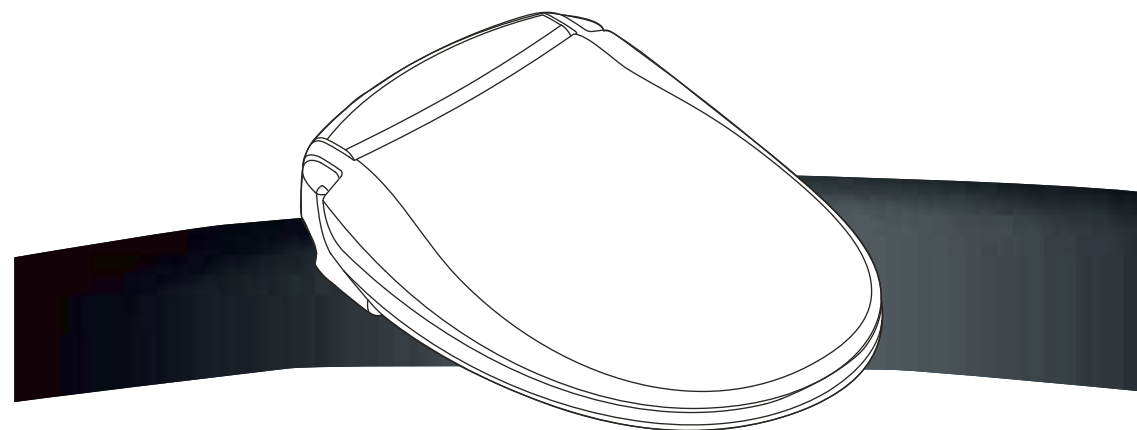

One Touch

CE RoHS



THIS PRODUCT SHOULD NOT BE DISPOSED WITH OTHER HOUSEHOLD WATES AT THIS END OF ITS WORKING LIFE. IN ORDER TO BE RECYCLE, PLEASE BRING YOUR PRODUCT IN A CERTIFIED RECYCLING CENTER.

E'LOO

 Please read the manual carefully prior to use

SUMMARY

01. Safety Precaution	03
02. Configuration	08
03. How To Use	09
04. Installation	10
05. Features	13
06. Maintenance	14
07. If the product is not use for a long period	15
08. Troubleshootings	16
09. Specification	18
10. Warranty Certificate	19

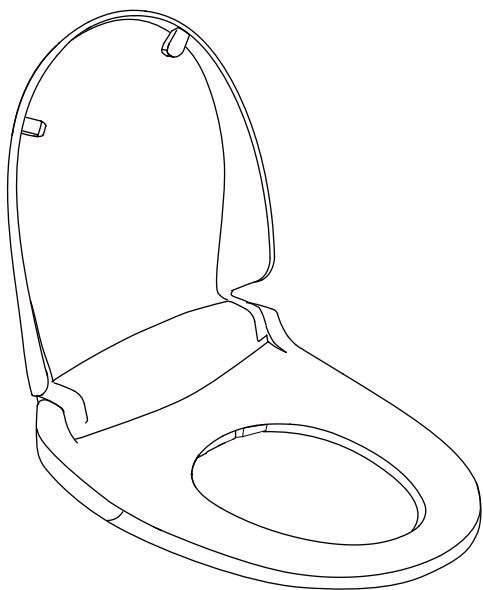

Warranty Certificate

Please fill in the blanks with the needed information of your warranty certificates immediately after installation.

In case of question to our after sales services they will be asked to you.

NAME OF THE PRODUCT : E'LOO
NAME OF THE MODEL : 8T Series
PRODUCT SERIALN :
(At the backside of the main unit)
PURCHASING DATE :
WARRANTY :

The manufacturing warranty is provided with in 1 year from the purchasing date (on the invoice).

The warranty includes services and all needed spare parts.

The warranty is only valid if all needed elements are given with a copy of the original invoice.

The warranty is valid for all defected parts resulting from manufacturing.

The warranty is not valid for parts damaged by the user or by installation non conform to E'LOO recommendations, for instance :

If the product had been disassemblea or repaired by non official technician from E'LOO.

The installation is not conforming to E'LOO recommendation.

The use is not conforming to E'LOO precaution of use.

The connection has been done on a non conforming plug.

Or all other damages caused by use or an installation that is not indicated in the E'LOO User Manual.

Specification

		8T Series Round	8T Series Elongated
Standard Power Voltage	230V 50 Hz		
Length Of The Power Cord	1.2m		
Supply Water Pressure	from 5 pascal to 69 pascal		
Heated Water	1200W (max.)		
Heated Seat	52W (max.)		
Heated Dryer	130W (max.)		
Electrical Safety Protection	15mA-GFCI		
Product	Dimension (mm)	470L x 385W x 107H	520L x 385W x 107H
	Net Weight	3.4 ± 0.3 Kg	
	Gross Weight	4.8 ± 0.5 Kg	
Certification	CE, RoHS		

Safety Precaution

IMPORTANT SAFETYGUARDS

- ⚠ DANGER** : If not observed, serious injury or even death may occur as a result of electrocution.
- ⚠ WARNING** : If these warnings, are not observed, considerable physical injury or property damage may occur as a result of burns, electrocution, fire, or injury.
- ⚠ CAUTION** : If these cautions are not observed, slight physical or property damage may occur.

READ ALL INSTRUCTIONS BEFORE USING.

Save these instructions for future reference.

When using electrical products, especially when children are present, basic safety precautions should always be taken:

⚠ DANGER: To reduce the risk of electrocution

Failure to observe the following warnings may result in electric shock, fire, personal injury, property damage or product damage :

- Do not use a damaged power plug or loose electric outlet.
- Make sure to use a dedicated electrical outlet. Failing to do so may result in electric shock or fire.
- Do not move the product by pulling the power cord.
- Do not handle the power plug with wet hands.
- Do not forcefully bend the power cord or place heavy objects on it to prevent it from being damaged or deformed.
- Do not connect and pull out the power plug repeatedly.
- Unplug the product before cleaning, repairing, inspecting, or replacing parts.
- Remove any dust or water from the power plug.
- Do not plug the appliance into an electrical outlet or power strip that is being used by too many appliances.
- Use an electrical outlet adequate for the wattage of the product.
- If the supply cord is damaged, it must be replaced by the manufacturer, its service agent or similarly qualified persons in order to avoid a hazard.

▲ DANGER: To reduce the risk of electrocution

- If the product produces a strange noise, a burnt smell, or emits smoke, unplug it immediately from the electrical outlet and call E'LOO Service Center. Failing to do so may result in electric shock or fire.
- Do not insert a wire or sharp object in any product gaps or the warm air outlet. This may result in electric shock, fire, or product damage.
- Do not place an electric heater near the product or dispose of any burning materials such as a lit cigarette in the toilet. This may result in fire or product deformation.
- Do not place any containers filled with water, medicine, food any metallic objects, or any flammable material on top of the product. If foreign material enters the product, this may result in electric shock or fire.
- Do not use the product in locations exposed to excessive moisture and do not splash water onto the product.
- Do not use the product if it is not working properly.
- Please unplug the product immediately, and call E'LOO Service Center after closing the main water supply valve. Failing to do so may result in electric shock or fire.
- While taking a shower or cleaning the bathroom, pull the power plug out of the electrical outlet and exercise caution that water or detergent does not splash onto the bidet. Failing to do so may result in electric shock or fire.
- If foreign material enters the product, pull the power plug out of the electrical outlet, turn off the main water valve, and call the E'LOO Service Center.
- Do not disassemble, repair, or modify the product yourself.
- Do not use the product while bathing.
- Do not place or store the product where it can fall or be pulled into a tub or sink.
- Do not place in or drop the product into water or any other liquid.
- Do not reach for the product if it has fallen into water. Unplug the product immediately. And call the E'LOO Service Center.

Prior to contact our after sales service, please contact the E'LOO in order to get further information for the warranty procedure. To facilitate the procedure, please prior answer the following questions?

QUESTIONS TO ANSWER :

The product is no more operating :

- 1- Isn't the power connection cable unplugged?
- 2- Isn't the power ON/OFF button switch off?
- 3- Does LED lamp on the control panel blinks or lights?
- 4- Is the user detected by the seat digital sensor?

Washing functions is no more operating :

- 1- Isn't the water supply valve shut off?
- 2- Isn't there any water leakage on the water supply connection pipe?
- 3- Isn't the water supply connection pipe clogged with foreign elements?
- 4- Isn't the nozzle clogged with foreign elements?
- 5- Isn't the nozzle clogged with limestone accumulation?
- 6- Is the LED lamp light or blinks?

Water pressure is weak :

- 1- Is the water supply valve fully open?
- 2- Isn't the water supply connection pipe clogged with foreign elements?
- 3- Isn't the water pressure level set to a too low level?

Water, air and seat temperature is no more operating :

- 1- Is the product connected to the plug?
- 2- Isn't the power ON/OFF button switch off?
- 3- Isn't the temperature level set to a too low level?

Troubleshootings

Please check the following before calling for service

Issue	Possible Cause	Solution
Press the button but the bidet does not work	<ul style="list-style-type: none"> ● Make sure the bidet is plugged in ● Start the air dryer during cleansing 	<ul style="list-style-type: none"> ● Plug in the power cord ● Start the air dryer when the cleansing stops
Low water pressure or no water supply	<ul style="list-style-type: none"> ● Is the water shut-off valve closed ● Twisted hose ● Clogged nozzles ● Dirty nozzle wand 	<ul style="list-style-type: none"> ● Open the water shut-off valve ● Straighten the hose ● Clean the nozzles ● Clean the nozzle wands
Water shuts off unexpectedly	<ul style="list-style-type: none"> ● Washing time exceeded 3 mins ● User not proper seated ● Power failure 	<ul style="list-style-type: none"> ● Unplug to reset ● Ensuring the active sensor is initiated ● Unplug and plug in again
Seat not heated	<ul style="list-style-type: none"> ● Seat temp. set to off ● Remote malfunction 	<ul style="list-style-type: none"> ● Reset the seat temp.
Water not heated	<ul style="list-style-type: none"> ● Water temp. set to off ● Remote malfunction 	<ul style="list-style-type: none"> ● Reset the water temp.
Dryer malfunction	<ul style="list-style-type: none"> ● Dryer temp. set to off ● Remote malfunction 	<ul style="list-style-type: none"> ● Reset the dryer temp.



Check if there is any abnormal status

- Constant leakage from product
- Crack on the seat
- There is no power when plug
- Burnt smell near the seat
- Electricity leakage
- Other malfunctions



Please stop using.

- Unplug the power cord.
- Close shut-off valve.
- Call the service center.

- Do not block the warm air outlet with your hand.
- Close supervision is necessary when this product is used by children or persons requiring general assistance.
- Use this product for its intended use only, as described in this manual. Do not use any attachments that are not recommended by E'LOO.
- Never block the air openings of the product or place it on a soft surface, such as a bed or couch, where the air openings may be blocked. Keep the air openings free of lint, hair, etc.
- Never drop or insert any object into any opening or hose.
- Do not use the product outdoors or operate where aerosol (spray) products are being used or where it could be exposed to oxygen.
- Unplug this product before filling. Fill (reservoir) with water only unless otherwise specified by the manufacturer. Do not overfill (or specify filling instructions).

CAUTION:

Failure to observe the following warnings may result in electric shock, fire, personal injury, property damage or product damage:

- Do not connect the main water to the hot water pipe (only connect to cold water supply).
- After the installation, make sure to check all water supply connections for leaks. Rubber washers should be in place for the water connection hoses & T-Valve.
- Exercise caution that urine does not come into contact with the nozzles or warm air dryer outlet-failure to do so may result in bad odors or malfunction.
- If the product will not be used for a long period of time unplug the power cord, close the main water supply valve, and drain any water in the water tank.
- Do not pull out the bidet hose or connection hose using excessive force.
- This appliance is not intended for use by persons [including children] with reduced physical, sensory or mental capabilities, or lack of experience and knowledge, unless they have been given supervision or instruction concerning use of the appliance by a person responsible for their safety. Children should be supervised to ensure that they do not play with the appliance.

Grounding & GFI Outlet Instructions

This product should only be used with a grounded GFI (Ground Fault Interrupter) outlet and a grounded 3 prong electrical cord as shown in figure A. In the event of an electrical short circuit, using a grounded GFI outlet reduces the risk of electric shock.

This product is equipped with a grounded cord and is for use on a

nominal 110V/220V circuit only (min 15 amps) and must be plugged into an outlet that is properly grounded with a GFI breaker as shown. Replace or repair a damaged cord immediately.

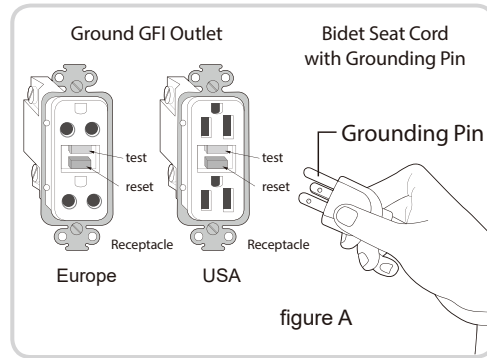

⚠ DANGER : Improper use of the grounding plug can result in a risk of electric shock.

- If repair or replacement of the cord or plug is necessary, do not connect the grounding wire to either flat blade terminal. The wire with insulation having an outer surface that is green with or without yellow stripes is the grounding wire.
- Check with a qualified electrician or serviceman if the grounding instructions are not completely understood, or if in doubt as to whether the product is properly grounded.

Extension Cord

If it is necessary to use an extension cord, use only a three wire extension cord with a threeblade grounding plug, and a three-slot receptacle that will accept the plug of the product. Replace or repair a damaged cord immediately.

In case the product is not use for a long period, we recommend to fully respect following operation :

STEP 1 Unplug the power cord.

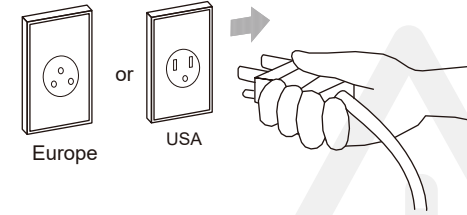

STEP 2 Turn off the tap water shut-off valve.

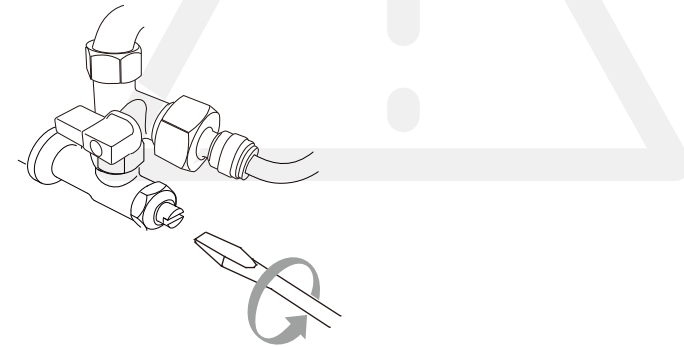

PRIOR TO REUSE THE 8T Series :

STEP 1 Open the water supply valve of the 8T Series.

STEP 2 Plug in the power cord.

Maintenance

- !** Do not spray water or cleaner directly on the seat. Wipe the product and components with a soft damp cloth.
Please keep dry and well ventilated place where installed the seat. A humid environment should cause the seat malfunction.

1 Cleaning The Seat

Apply to water, 75% diluted alcohol or soft detergent on soft cloth for wiping clean the seat.

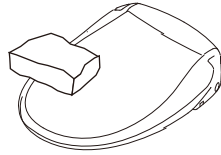

2 Cleaning The Toilet Fixture

1. Press the detach button to remove the seat.
2. Clean up the corner and surface of toilet fixture.
3. Re-install the seat onto toilet fixture and make it sure mounted properly with hearing "click" sound.

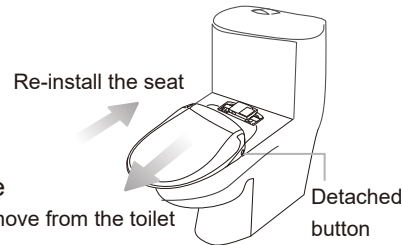

3 Cleaning The Nozzles

1. Apply to soft detergent on brush to clean nozzles and wands regularly.

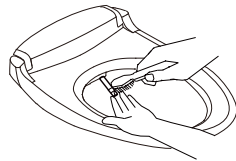

Safety Precaution

- !** Do not use the product if it is working improperly, and call for Service :



Set the temperature of wash spray, warm air dryer, and seat to "low" or "off" to prevent burning.



The product should be used with correct electrical current only to avoid possible fire or shock. An approved residual current device (RCD) must be used.



Do not self disassemble, repair or modify the seat.



Do not water on the seat directly, this could result in damage.



Do not use hard brushes or abrasive detergent to clean this product. Use only neutral detergent and a damp soft cloth for cleaning.



Keep any flammable material away from the seat all the time to prevent a fire hazard happen.



Do not stand or weight heavily on the seat to prevent seat cracking or causing people injury.



Do not bend or pinch the hose : It could affect the normal water supply and cause malfunction or improper working.



During low water pressure, skin burn may occur due to the water temperature coming out from the nozzles increase rapidly. Extra care is needed.



Avoid dropping the remote or getting wet : it will cause malfunction. Do not press the buttons using excessive force.



If the product is not to be used for an extended period of time, unplug the power cord. Never operate this product if it has a damaged cord or plug, if it is not working properly, if it has been dropped or damaged, or dropped into water. Return the product to a service center for examination and repair. Connect this product to a properly grounded outlet only. Refer to the Grounding Instructions.

Configuration

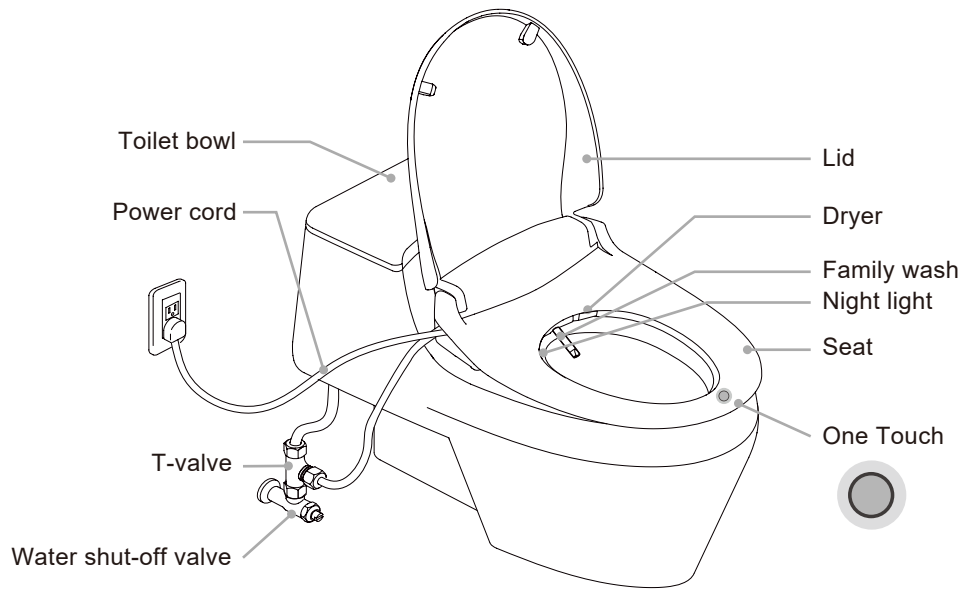

Accessories

Instruction	Mounting Plate	T-valve
<p>8TF USER MANUAL</p> <p>One Touch</p>	<p>x2</p> <p>x2</p> <p>x2</p> <p>x1</p>	<p>T-Valve / Hose x1</p>

Features

ONE TOUCH can only be efficient if the user has correctly adjusted all parameters of use and if the user is really full relaxed.



Family Wash

A rear wash with stream of water which cleans an individual's posterior more thoroughly.



Fit Most Existing Toilet Fixtures

It comes in two sizes, elongated and round to fit any standard-size toilet.



Single Nozzle Design

A self-cleaning retractable wand is designed, for the family cleanse.



Warm Air Dryer

Providing an additional touch of tender service to dry the moisture that staying on the buttock after washing and less toilet paper usage.



Quick Release

Push the button located at the back right side of the seat, and you can release the seat from the mounting plate friendly.



Warm Seat

The user may adjust the seat temperature to their preferred temperature in accordance with the external weather conditions as well as their personal needs.

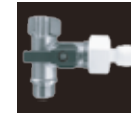

Built-In T-Valve

A T-valve adapts at the angle valve of tap water to divert the water for both seat and water flush.



Night Light

LED night light that illuminates the entire toilet bowl. It makes toilet environment more comfortable and safty.



Anti-Bacterial Material

The nozzles and seat made by a special germ-resistant plastic that offers up to 99.8% of anti-bacterial protection.

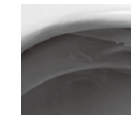

UV Sterilization

The all-new UV light device eliminates germs and harmful bacteria for improved hygiene.



Gentle Closing Seat & Lid

The design allows the seat and lid to close softly which is safety and less noisy.

⚠ Important Notice

※ Ensuring the seat sensor is initiated before water wash

※ Nozzles Self-Cleaning and UV Sterilization







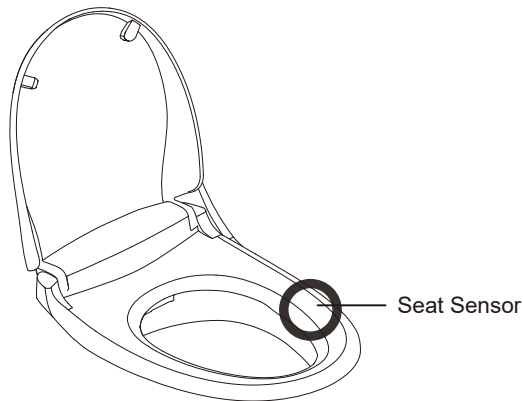



1. Nozzles self-cleaning will be activated automatically before and after each use.
2. The UV light is activated for 3 mins duration automatically when user left the seat.

※ Low Water Pressure

1. If the user feels the water temperature increase rapidly at low water pressure, please lower the water temperature setting immediately to prevent possible skin burn.
2. Please check the following for trouble shooting:
 - a. Supply of water : Ensuring the source of the water is working normally.
 - b. Shut-off valve : Ensuring the valve is opened properly.
 - c. T-valve filter : Ensuring the filter is not blocked.



How To Use

Function	How to operate									
 Water Cleaning	1. Tabbing on the  One Touch to activate water cleaning in 3 minutes default.									
 Air dryer	1. Tabbing the  One Touch to switch for air dryer in 3 minutes default while water cleaning is working. 2. Tabbing the  One Touch to stop the air dryer while air dryer is working. ※ Tabbing the  One Touch for cycling again before you left the seat.									
 Water/Dryer/Seat Temperature	1. Tabbing on the  One Touch for 3 seconds to switch the temperature of water/dryer and seat on/off alternately while water cleaning is working. <table border="1" data-bbox="1447 719 2112 831"> <thead> <tr> <th>Status</th> <th>Bule LED</th> <th>Red LED</th> </tr> </thead> <tbody> <tr> <td>Water / Seat Temp</td> <td>Room temp.</td> <td>Med(37 ± 2°C Approx.)</td> </tr> <tr> <td>Dryer Temp</td> <td>Room temp.</td> <td>Med(45 ± 2°C Approx.)</td> </tr> </tbody> </table>	Status	Bule LED	Red LED	Water / Seat Temp	Room temp.	Med(37 ± 2°C Approx.)	Dryer Temp	Room temp.	Med(45 ± 2°C Approx.)
Status	Bule LED	Red LED								
Water / Seat Temp	Room temp.	Med(37 ± 2°C Approx.)								
Dryer Temp	Room temp.	Med(45 ± 2°C Approx.)								
 Notes	1. Tabbing on the  One Touch button for turn the night light on/off before seating.									

STEP 1. Before installation

1. Remove the existing toilet seat.
Steps may vary by type of seat.

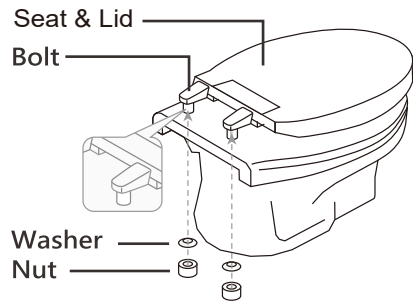

2. Turn water valve off completely and flush to empty the toilet tank.

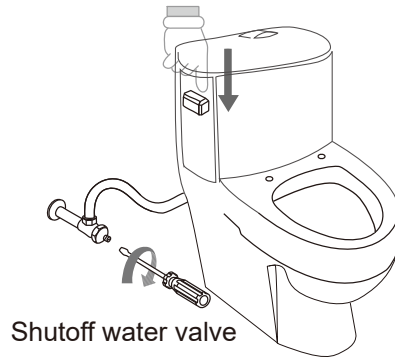

STEP 2. Install Mounting Plate

The mounting plate and washers must be assembled correctly as instructed.

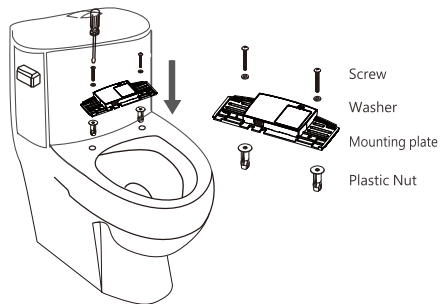

STEP 3. Connect T-valve and Hoses

The T-valve is required to install properly as the build-in filter keeps out the impurities from the tap water. Failure to do so could result in leaking.

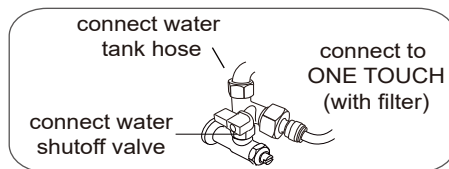

STEP 4. Attaching & Detaching the product

Slide the product onto the mounting plate. You will hear a "Clicking" indicating the seat has been properly attached. And a "Clicking" sound indicating it has been attached properly.

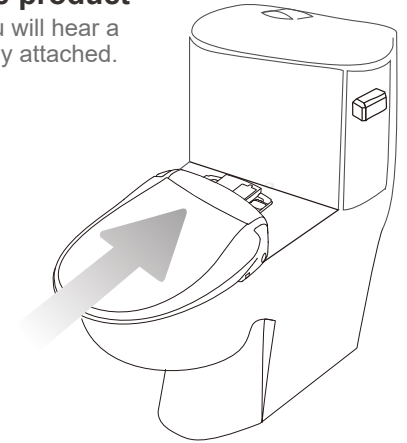

STEP 5. Test Operation

Turn on the water valve properly and plug in power cord. You will hear the shorter "Beep" sound. The night light will be turn on. And it takes around 15 seconds to start up and then hear the "Beep" sound when it is ready to use.

Warning: In case the water spray out unexpected. Please unplug and restart it.

